



DS-K1801 Series Card Reader

User Manual

©2021 Hangzhou Hikvision Digital Technology Co., Ltd. All rights reserved.

About this Manual

The Manual includes instructions for using and managing the Product. Pictures, charts, images and all other information hereinafter are for description and explanation only. The information contained in the Manual is subject to change, without notice, due to firmware updates or other reasons. Please find the latest version of this Manual at the Hikvision website (<https://www.hikvision.com/>).

Please use this Manual with the guidance and assistance of professionals trained in supporting the Product.

Trademarks

HIKVISION and other Hikvision's trademarks and logos are the properties of Hikvision in various jurisdictions.

Other trademarks and logos mentioned are the properties of their respective owners.

Disclaimer

TO THE MAXIMUM EXTENT PERMITTED BY APPLICABLE LAW, THIS MANUAL AND THE PRODUCT DESCRIBED, WITH ITS HARDWARE, SOFTWARE AND FIRMWARE, ARE PROVIDED "AS IS" AND "WITH ALL FAULTS AND ERRORS". HIKVISION MAKES NO WARRANTIES, EXPRESS OR IMPLIED, INCLUDING WITHOUT LIMITATION, MERCHANTABILITY, SATISFACTORY QUALITY, OR FITNESS FOR A PARTICULAR PURPOSE. THE USE OF THE PRODUCT BY YOU IS AT YOUR OWN RISK. IN NO EVENT WILL HIKVISION BE LIABLE TO YOU FOR ANY SPECIAL, CONSEQUENTIAL, INCIDENTAL, OR INDIRECT DAMAGES, INCLUDING, AMONG OTHERS, DAMAGES FOR LOSS OF BUSINESS PROFITS, BUSINESS INTERRUPTION, OR LOSS OF DATA,

CORRUPTION OF SYSTEMS, OR LOSS OF DOCUMENTATION, WHETHER BASED ON BREACH OF CONTRACT, TORT (INCLUDING NEGLIGENCE), PRODUCT LIABILITY, OR OTHERWISE, IN CONNECTION WITH THE USE OF THE PRODUCT, EVEN IF HIKVISION HAS BEEN ADVISED OF THE POSSIBILITY OF SUCH DAMAGES OR LOSS.

YOU ACKNOWLEDGE THAT THE NATURE OF THE INTERNET PROVIDES FOR INHERENT SECURITY RISKS, AND HIKVISION SHALL NOT TAKE ANY RESPONSIBILITIES FOR ABNORMAL OPERATION, PRIVACY LEAKAGE OR OTHER DAMAGES RESULTING FROM CYBER-ATTACK, HACKER ATTACK, VIRUS INFECTION, OR OTHER INTERNET SECURITY RISKS; HOWEVER, HIKVISION WILL PROVIDE TIMELY TECHNICAL SUPPORT IF REQUIRED.

YOU AGREE TO USE THIS PRODUCT IN COMPLIANCE WITH ALL APPLICABLE LAWS, AND YOU ARE SOLELY RESPONSIBLE FOR ENSURING THAT YOUR USE CONFORMS TO THE APPLICABLE LAW. ESPECIALLY, YOU ARE RESPONSIBLE, FOR USING THIS PRODUCT IN A MANNER THAT DOES NOT INFRINGE ON THE RIGHTS OF THIRD PARTIES, INCLUDING WITHOUT LIMITATION, RIGHTS OF PUBLICITY, INTELLECTUAL PROPERTY RIGHTS, OR DATA PROTECTION AND OTHER PRIVACY RIGHTS. YOU SHALL NOT USE THIS PRODUCT FOR ANY PROHIBITED END-USES, INCLUDING THE DEVELOPMENT OR PRODUCTION OF WEAPONS OF MASS DESTRUCTION, THE DEVELOPMENT OR PRODUCTION OF CHEMICAL OR BIOLOGICAL WEAPONS, ANY ACTIVITIES IN THE CONTEXT RELATED TO ANY NUCLEAR EXPLOSIVE OR UNSAFE NUCLEAR FUEL-CYCLE, OR IN SUPPORT OF HUMAN RIGHTS ABUSES.

IN THE EVENT OF ANY CONFLICTS BETWEEN THIS MANUAL AND THE APPLICABLE LAW, THE LATTER PREVAILS.

Regulatory Information

FCC Information

Please take attention that changes or modification not expressly approved by the party responsible for compliance could void the user's authority to operate the equipment.

FCC compliance: This equipment has been tested and found to comply with the limits for a Class A digital device, pursuant to part 15 of the FCC Rules. These limits are designed to provide reasonable protection against harmful interference when the equipment is operated in a commercial environment. This equipment generates, uses, and can radiate radio frequency energy and, if not installed and used in accordance with the instruction manual, may cause harmful interference to radio communications. Operation of this equipment in a residential area is likely to cause harmful interference in which case the user will be required to correct the interference at his own expense.

FCC Conditions

This device complies with part 15 of the FCC Rules. Operation is subject to the following two conditions:

1. This device may not cause harmful interference.
2. This device must accept any interference received, including interference that may cause undesired operation.

EU Conformity Statement



This product and - if applicable - the supplied accessories too are marked with "CE" and comply therefore with the applicable harmonized European standards listed under the EMC Directive 2014/30/EU, the RoHS Directive 2011/65/EU.



2012/19/EU (WEEE directive): Products marked with this symbol cannot be disposed of as unsorted municipal waste in the European Union. For proper recycling, return this product to your local supplier upon the

purchase of equivalent new equipment, or dispose of it at designated collection points. For more information see: www.recyclethis.info.



2006/66/EC (battery directive): This product contains a battery that cannot be disposed of as unsorted municipal waste in the European Union. See the product documentation for specific battery information. The battery is marked with this symbol, which may include lettering to indicate cadmium (Cd), lead (Pb), or mercury (Hg). For proper recycling, return the battery to your supplier or to a designated collection point. For more information see: www.recyclethis.info.

Industry Canada ICES-003 Compliance

This device meets the CAN ICES-3 (A)/NMB-3(A) standards requirements.

Use only power supplies listed in the user instructions:

Model	Manufacturer	Standard
TS-A018-120015Ec	Shenzhen Transin Technologies Co., Ltd	CEE



Safety Instruction

These instructions are intended to ensure that user can use the product correctly to avoid danger or property loss.

The precaution measure is divided into **Warnings** and **Cautions**:

Warnings: Neglecting any of the warnings may cause serious injury or death.

Cautions: Neglecting any of the cautions may cause injury or equipment damage.

	
Warnings Follow these safeguards to prevent serious injury or death.	Cautions Follow these precautions to prevent potential injury or material damage.



Warnings

- All the electronic operation should be strictly compliance with the electrical safety regulations, fire prevention regulations and other related regulations in your local region.
- Please use the power adapter, which is provided by normal company. The power consumption cannot be less than the required value.
- Do not connect several devices to one power adapter as adapter overload may cause over-heat or fire hazard.
- Please make sure that the power has been disconnected before you wire, install or dismantle the device.
- When the product is installed on wall or ceiling, the device shall be firmly fixed.
- If smoke, odors or noise rise from the device, turn off the power at once and unplug the power cable, and then please contact the service center.
- If the product does not work properly, please contact your dealer or the nearest service center. Never attempt to disassemble the device yourself. (We shall not assume any responsibility for problems caused by unauthorized repair or maintenance.)



Cautions

- Do not drop the device or subject it to physical shock, and do not expose it to high electromagnetic radiation. Avoid the

DS-K1801 Series Card Reader

equipment installation on vibrations surface or places subject to shock (ignorance can cause equipment damage).

- Do not place the device in extremely hot (refer to the specification of the device for the detailed operating temperature), cold, dusty or damp locations, and do not expose it to high electromagnetic radiation. The appropriate temperature is -20°C to 65°C .
- The device cover for indoor use shall be kept from rain and moisture.
- Exposing the equipment to direct sun light, low ventilation or heat source such as heater or radiator is forbidden (ignorance can cause fire danger).
- Do not aim the device at the sun or extra bright places. A blooming or smear may occur otherwise (which is not a malfunction however), and affecting the endurance of sensor at the same time.
- Please use a soft and dry cloth when clean inside and outside surfaces of the device cover, do not use alkaline detergents.
- Please keep all wrappers after unpack them for future use. In case of any failure occurred, you need to return the device to the factory with the original wrapper. Transportation without the original wrapper may result in damage on the device and lead to additional costs.
- Improper use or replacement of the battery may result in hazard of explosion. Replace with the same or equivalent type only. Dispose of used batteries according to the instructions provided by the battery manufacturer.

Content

Chapter 1	Preventive and Cautionary Tips	1
Chapter 2	Introduction.....	2
2.1	Front View.....	2
2.2	Side View and Rear View.....	2
Chapter 3	Wiring and Installation.....	3
3.1	Terminal Description.....	3
3.2	Wiring Cables	3
3.3	Installing Card Reader	4
Chapter 4	Sound Prompt and Indicator	5

Chapter 1 Preventive and Cautionary Tips

To guarantee the card reader works properly, please read and obey the notes below.

- If the card reader is powered by the controller, the power supply distance is recommended to be no longer than 100m. If the distance is longer than 100m, you are advised to power the card reader by external 12 V (range: $-10\% \sim +10\%$) DC power supply, which is nonswitched and linear.
- To guarantee the communication between the controller and the card reader, you must use RVVP cable above 0.5 to connect them.
- If the card reader is installed outside or in environment easy to permeable, it is advisable to install a waterproof shield.
- If you need to install several card readers, the distance among them must over 30 cm.
- To reduce the noise in long distance transmission, the shield of cable should connect to the GND of both controller and card reader terminal.

Chapter 2 Introduction

2.1 Front View

The front view of DS-K1801 series card reader is shown below:

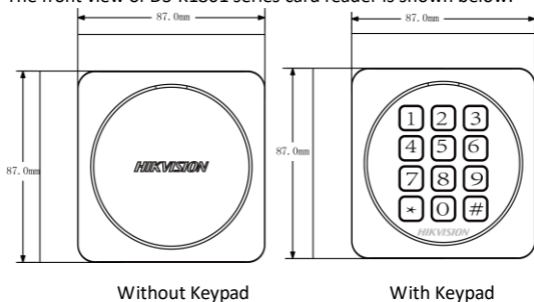

2.2 Side View and Rear View

The side view of card reader is shown below:

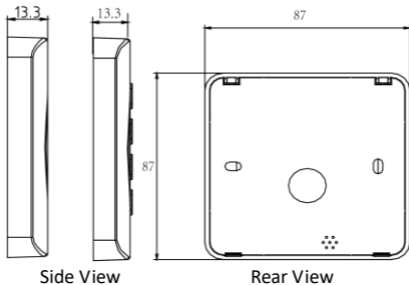

Chapter 3 Wiring and Installation

3.1 Terminal Description

The description of 8 cables is shown below.

Table 3-1 Description of Cable

Color	Description
Red	PWR (12 VDC)
Black	GND
Purple	Beep Control
Brown	OK
Orange	ERR
Green	Wiegand W0
White	Wiegand W1
Blue	Wiegand 26/ 34

3.2 Wiring Cables

Purpose:

Wire the cables between controller and card reader, thus to establish the communication between them.

Steps for Wiegand communication mode:

Wiring the cable between controller and card reader as shown below.

1. Set the Wiegand mode before power-on:

Cable	Wiring Method	Wiegand Mode
Blue Wiegand Cable	Grounded	Wiegand 26
	Not Grounded	Wiegand 34

2. Wiring the cable between controller and card reader as shown

below.

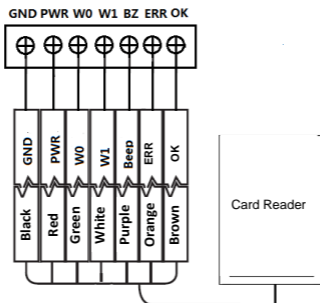
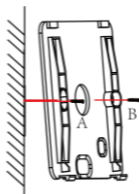

Figure 3-1 Wiring for Wiegand Communication Mode

3.3 Installing Card Reader

Steps:

1. Fix the plate on the wall with screws (A and B) or other place with flat surface.



2. Connect the cables between controller and card reader. For

details, refer to 3.2 Wiring Cables.

- Buckle the card reader up to the plate with aligning C point and the corresponded slot on the upper side of card reader .
- Press the lower side of the card reader to fasten the card reader on D point of the plate.

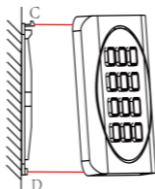

Chapter 4 Sound Prompt and Indicator

After the card reader is powered on, LED status indicator will turn green and blink for 1 time. Then it will turn red and blink for 3 times. At last the buzzer will send out a beep sound indicating the starting up process is completed.

During using the card reader, it will send out different sounds prompt and the LED indicator on it have different statuses. You can refer to tables below for detailed information.

Table 4-1 Description of Prompt Sound

Sound Prompt	Description
One beep	Swiping card prompt
	Pressing keys prompt
	Prompt for too long card No. input by pressing keys.
	Time out prompt for pressing keys or swiping card.
	For Card + Password authentication: prompt for entering the password after swiping the card.

DS-K1801 Series Card Reader

Sound Prompt	Description
Two rapid beeps	The operation of pressing keys or swiping card is valid.
Three slow beeps	The operation of pressing keys or swiping card is invalid.
Rapidly continuous beeps	Prompt for tamper-proof alarm.
	Prompt for buzzer alarm.
Slowly continuous beeps	The card reader is unencrypted.

Table 4-2 Description of LED Indicator

LED Indicator Status	Description
Green (blink for 1 time), and red (blink for 3 times)	The card reader is power on.
Green and slow blinking	For Card + Password authentication: prompt for entering the password after swiping the card.
Solid green for 3s	The operation of pressing keys or swiping card is valid.
Green and Intermittent blinking	Card reader is working normally.
Solid red for 3s	The operation of pressing keys or swiping card is invalid.

0200001080912



UD05259B-D